

## CABLE DRAG CHAIN : T SERIES

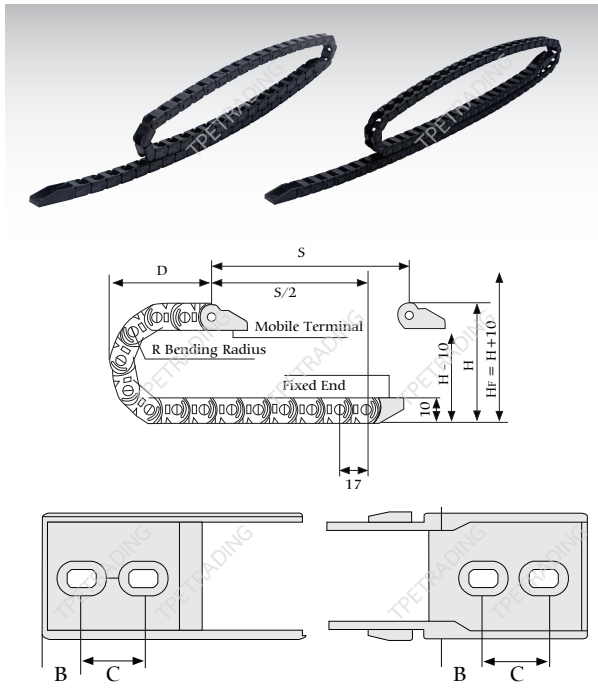

### T6 / T7 / T8 Mini Series



#### Main Technical Parameters

**Material** Plastic PA6

##### 6 Series

Pitch = 13mm. , excluding the number of joints per meter = 77,  
chain length =  $s / 2 + K$ , s = strokeDistance,  
 $k = \pi.R + \text{"safety quantity"}$

##### 7 Series

Pitch = 17mm. , knots per meter excluding joint = 59  
chain length =  $s / 2 + K$ , s = strokeDistance,  
 $k = \pi.R + \text{"safety quantity"}$

##### 8 Series

Pitch = 16mm. , knots per meter excluding joint = 69,  
chain length =  $s / 2 + K$ , s = strokeDistance,  
 $k = \pi.R + \text{"safety quantity"}$

6 Series	
R	15
H	39
D	33
K	75

7 Series		
R	15	28
H	40	66
D	37	50
K	80	121

8 Series	
R	18
H	47
D	41
K	91

#### Technical Parameters

Serial Number	Inner Height	Inner Width	Outer Height	Outer Width	Bending Radius(R)	Open Mode	Aperture	Corresponding Joint Hole Distance(mm)	Connector Ordering model
T6 Mini Series	6	10	9	15	15	Bridge Open	3.2 x 4.7	B = 5, C = 8	6.10.W.12PZ
T7 Mini Series	7	7	10	14	15, 28	Bridge Cannot be Opened	3.0 x 4.5	B = 5, C = 8	7.7.B.12PZ
T8 Mini Series	8	8	11	15	18	Bridge Cannot be Opened	3.5 x 5.0	B = 5, C = 9	8.8.B.12PZ

**\*\*บริษัท ขอสงวนสิทธิ์การเปลี่ยนแปลงราคา โดยมีต้นสังกัดให้ทราบล่วงหน้า\*\***  
 ส่วนติดต่อจัดจำหน่าย Tel 02-027-7841, 095-543-5665 / Fax 02-026-6529  
 Email : sales.tpetrading@gmail.com / ID Line : @tpetrading

## T10 Mini Series



R	18	28	38
H	51	71	91
D	47	57	67
K	101	133	164

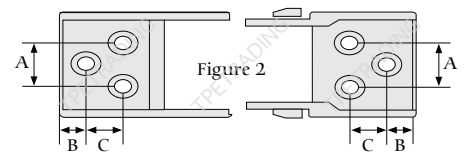
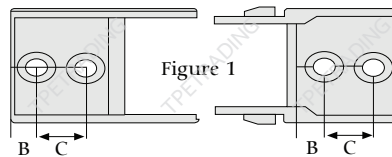
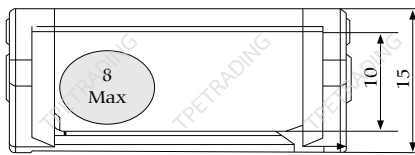

### Main Technical Parameters

**Material** Plastic PA6

Pitch = 20.7mm. , excluding the number of joints per meter = 49, chain length =  $s/2 + K$ ,  $s$  = strokeDistance,  $k = \pi.R +$  "safety quantity"

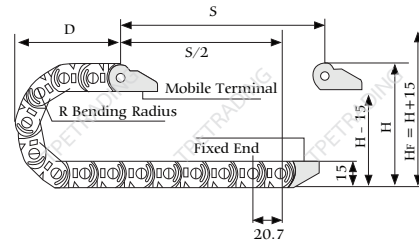

### Technical Parameters

Serial Number	Inner Height	Inner Width	Outer Height	Outer Width	Bending Radius(R)	Open Mode	Aperture	Corresponding Joint Hole Distance(mm)	Connector Ordering model
T10 Mini Series	10	10	15	18	18, 28, 38	Bridge Cannot be Opened	4 x 7L	B = 8, C = 9	10.10.B.12PZ (Figure 1)
	10	15	15	23				B = 8, C = 9	10.15.B.12PZ (Figure 1)
	10	20	15	28				A = 12, B = 8, C = 9	10.20.B.12PZ (Figure 2)
	10	30	15	38				A = 12, B = 8, C = 9	10.30.B.12PZ (Figure 2)

## T15 Small Series



R	28	38	48
H	76	96	116
D	59	69	79
K	140	171	203

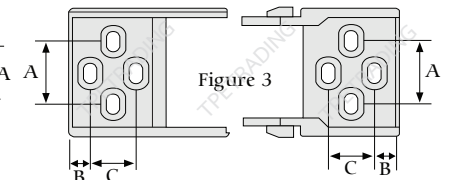
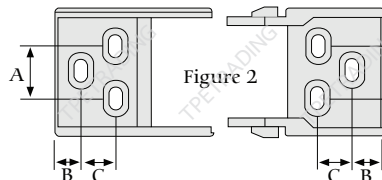
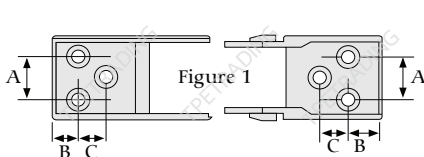

### Main Technical Parameters

**Material** Plastic PA6

Pitch = 20.2mm. , excluding the number of joints per meter = 50, chain length =  $s/2 + K$ ,  $s$  = rowDistance,  $k = \pi.R +$  "safety quantity"

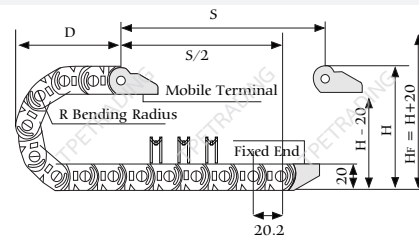

### Technical Parameters

Serial Number	Inner Height	Inner Width	Outer Height	Outer Width	Bending Radius(R)	Open Mode	Aperture	Corresponding Joint Hole Distance(mm)	Connector Ordering model
T15 Small Series Semi Closed	15	15	20	25	28, 38, 48	Semi Closed Inner Opening	4 x 7L	A = 9.5, B = 9.5, C = 6.5	15.15.BF.12PZ (Figure 1)
	15	20	20	30				A = 10, B = 4, C = 6.5	15.20.BF.12PZ (Figure 2)
	15	30	20	40				A = 20, B = 3.5, C = 12	15.30.BF.12PZ (Figure 3)
	15	40	20	50				A = 28, B = 4.5, C = 14	15.40.BF.12PZ (Figure 3)
	15	50	20	60				A = 40, B = 4, C = 12	15.50.BF.12PZ (Figure 3)



## T18 Small Series

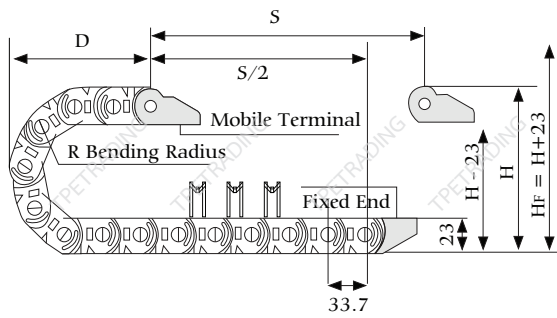

### Main Technical Parameters

**Material** Plastic PA6

Pitch = 33.7mm. , excluding the number of joints per meter = 30, chain length =  $s / 2 + K$ ,  $s$  = strokeDistance,  $k = \pi \cdot R +$  "safety quantity"

R	28	38	48	55	60	75	100
H	79	99	119	133	143	173	223
D	74	84	94	101	106	121	146
K	158	190	221	243	259	306	384

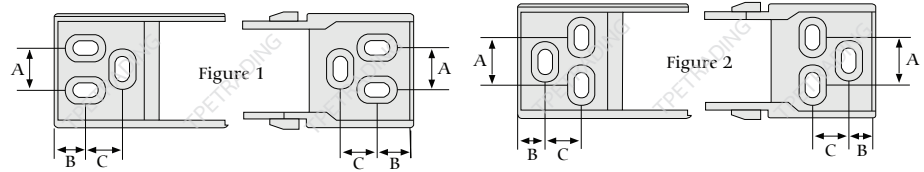
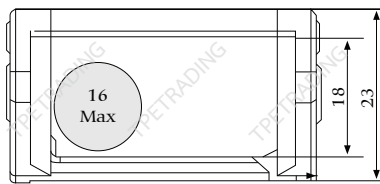

### Technical Parameters

Serial Number	Inner Height	Inner Width	Outer Height	Outer Width	Bending Radius(R)	Open Mode	Aperture	Corresponding Joint Hole Distance(mm)	Connector Ordering model
T18 Small Series Semi Closed	18	18	23	29	28, 38, 48, 55, 60, 75, 100	Semi Closed Inner Opening	5 x 7L	A = 8, B = 11.5, C = 9	18.18.BF.12PZ (Figure 1)
	18	25	23	36			5 x 8.5L	A = 12, B = 7.5, C = 11	18.25.BF.12PZ (Figure 2)
	18	37	23	47			5 x 9L	A = 24.5, B = 7.5, C = 7.5	18.37.BF.12PZ (Figure 2)
	18	50	23	60			5 x 9L	A = 37.5, B = 8, C = 7	18.50.BF.12PZ (Figure 2)
T18 Small Series Bridge	18	18	23	24	38, 48, 60	Bridge Opening	5 x 7L	A = 8, B = 11.5, C = 9	18.18.Q.12PZ (Figure 1)
	18	25	23	36			5 x 8.5L	A = 12, B = 7.5, C = 11	18.25.Q.12PZ (Figure 2)
	18	37	23	47			5 x 9L	A = 24.5, B = 7.5, C = 7.5	18.37.Q.12PZ (Figure 2)
	18	50	23	60			5 x 9L	A = 37.5, B = 8, C = 7	18.50.Q.12PZ (Figure 2)



## T25 Black Economy Series

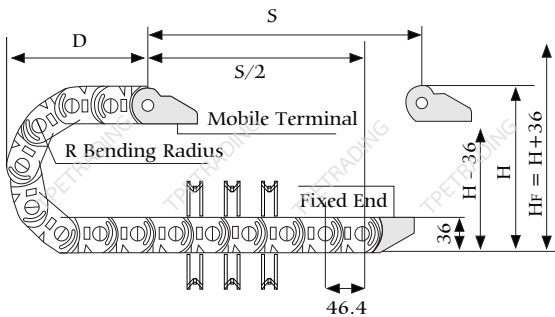

### Main Technical Parameters

Material : Plastic PA6

Pitch = 46.4mm. , excluding the number of joints per meter = 22, chain length =  $s / 2 + K$ ,  $s$  = strokeDistance,  $k = \pi.R +$  "safety quantity"

R	40	55	75	100	125	150	175
H	116	146	186	236	286	336	386
D	105	120	140	165	190	215	240
K	229	276	339	417	496	574	653

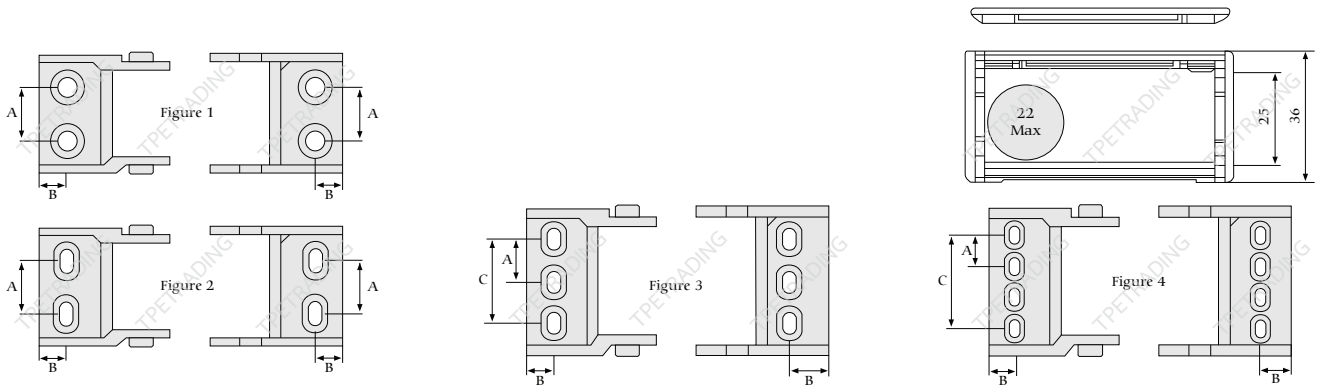

### Technical Parameters

Serial Number	Inner Height	Inner Width	Outer Height	Outer Width	Bending Radius(R)	Open Mode	Aperture	Corresponding Joint Hole Distance(mm)	Connector Ordering model
T25 Series	25	25	36	40	40, 55, 75, 100, 125, 150, 175	Bridge Type	6.3	A = 14, B = 11.5	25.25.Q.12PZ (Figure 1)
	25	38	36	53		Bridge / Closed	6.3 x 11.3	A = 22, B = 11.5	25.38.Q(F).12PZ (Figure 2)
	25	50	36	65		Bridge / Closed	6.3 x 16.3	A = 29, B = 11.5	25.50.Q(F).12PZ (Figure 2)
	25	57	36	72		Bridge / Closed		A = 36, B = 11.5	25.57.Q(F).12PZ (Figure 2)
	25	60	36	75		Bridge / Closed		A = 36, B = 11.5	25.60.Q(F).12PZ (Figure 2)
	25	77	36	92		Bridge / Closed		A = 28, B = 11.5, C = 56	25.77.Q(F).12PZ (Figure 32)
	25	103	36	118		Bridge Type		A = 27.5, B = 11.5, C = 82.5	25.103.Q.12PZ (Figure 4)